



Pali Design, Inc

1525 Hymus Boul.
Dorval, QC
H9P-1J5 Canada
Phone: 1-514-421-0309

customerservice@pali-design.com

www.pali-design.com

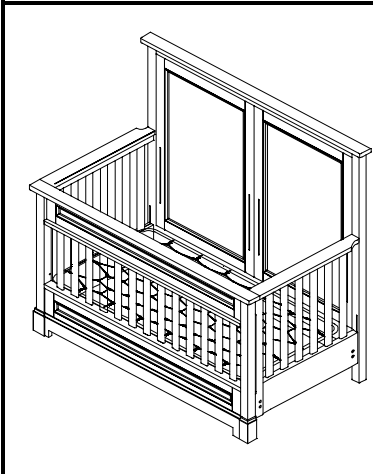

Assembly Instructions

Aria Forever Crib



This crib has been designed for your child's comfort and your convenience. Quality material and workmanship have gone into this crib which will provide a sound and comfortable bed for your baby if properly assembled and maintained. For the security of your child and your own peace of mind be sure to follow the assembly instructions exactly. Adult assembly is required. A periodic check should be made of all bolts and screws, which should be tightened if needed. Moisture and heat are harmful to the finish; for this reason use extreme caution when vaporizer is in use. The vapor steam should always be aimed away from the crib as well as away from other wood furniture. Some types of soft plastic toys could damage the finish when placed against it.

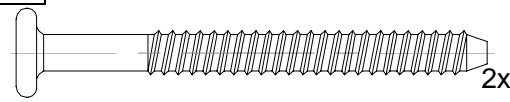
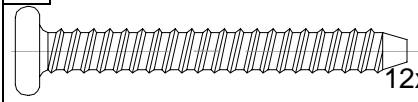
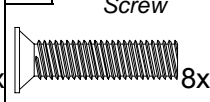
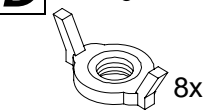
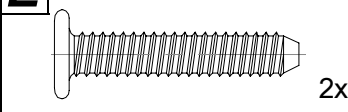
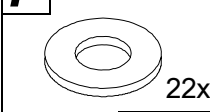
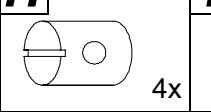
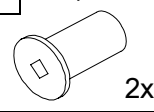
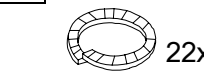
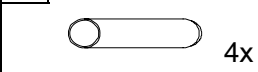

Hardware Parts list

A Large Allenhead Bolt  2x	B Small Allenhead Bolt  12x	C Phillips Head Screw  8x
D Wing Nut  8x	E Allenhead Bolt  2x	F Washer  22x
H KD Nut  4x	I Cap Nut  2x	
J Lock Washer  22x	K Iron Pin  4x	L Allen Wrench  2x

INSTRUCTION LEAFLET
Adult assembly is required
Important, keep for future reference. Read carefully.

IMPORTANT: In order to properly assemble the crib, carry out the operations in the order specified. Failure to assemble the crib in the manner recommended could make the crib hazardous. Carefully remove and lay out all parts. Familiarize yourself with all diagrams to facilitate the assembly of your crib. Check parts enclosed in hardware bag with the **HARDWARE PARTS LIST** to be sure all are included and quantities are correct.

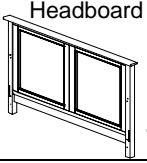
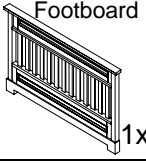
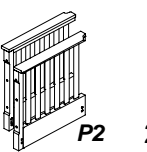
Crib Parts List:

M Headboard  1x	N Footboard  1x
P End Panels  2x	Q Mattress support  1x
R Stabilizer Bar  2x	

Hardware Preparation

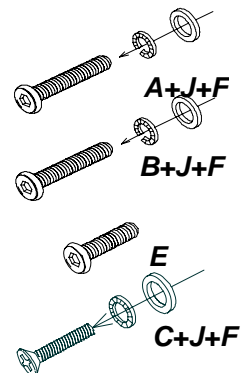



WARNING STATEMENTS

Failure to follow these warnings and the assembly instructions could result in serious injury or death. Read all instructions before assembling crib. Keep instructions for future use.

- Never use plastic shipping bags or other plastic film as mattress covers because they can cause suffocation.
- Infants can suffocate in gaps between crib sides and a mattress that is too small.
- Infants can suffocate on soft bedding. Never add a pillow or comforter. Never place additional padding under an infant.
- To reduce the risk of SIDS, pediatricians recommend healthy infants to be placed on their backs to sleep, unless otherwise advised by your physician.

STRANGULATION HAZARD

- Strings can cause strangulation! Do not place items with a string around a child's neck, such as hood strings or pacifier cords. Do not suspend strings over a crib or attach strings to toys.
- To help prevent strangulation tighten all fasteners. A child can trap parts of the body or clothing on loose fasteners.
- **DO NOT** place crib near window where cords from blinds or drapes may strangle a child.

FALL HAZARD

- When child is able to pull to a standing position, set mattress to lowest position and remove bumper pads, large toys and other objects that could serve as steps for climbing out.
- Stop using crib when child begins to climb out or reaches the height of 35 in. (89 cm).
- Check this product for damaged hardware, loose joints, loose bolts or other fasteners, missing parts or sharp edges before and after assembly and frequently during use. **DO NOT** use crib if any parts are missing, damaged or broken. Contact Pali for replacement parts and instructional literature if needed. **DO NOT** substitute parts.

OTHER HAZARDS

- If refinishing, use a non-toxic finish specified for children's products.
- Follow warnings on all products in a crib.
- Do not use this crib if the enclosed or attached instructions cannot be strictly adhered to.
- Do not use this crib if the child is able to climb out unaided or is taller than 90 cm.
- Do not place cords, straps or similar items that could become wound around the child's neck in or near this crib.
- Ensure that the sides are properly latched or locked in place when the crib is occupied.
- The mattress used with this crib should not be more than 15 cm thick and should be of such length and width that the gap between the mattress and the sides of the crib is not more than 3 cm when the mattress is pushed into the corner of the crib.
- The mattress intended for use on the crib shall be a full-size crib mattress having minimum dimensions of 51 5/8 in. (1310 mm) in length, 27 1/4 in. (690 mm) in width and 6 in. (150 mm) in thickness.



TODDLER BED WARNING ENTRAPMENT/ STRANGULATION HAZARD

Infants have died in toddler beds from entrapment and strangulation. Failure to follow these warnings and the assembly instructions could result in serious injury or death from entrapment or strangulation.

- NEVER use bed with children under 15 months.
- NEVER place bed near window where cords from blinds or drapes may strangle a child.
- The mattress intended for use on the bed shall be a full-size crib mattress having minimum dimensions of 51 5/8 in. (1310 mm) in length, 27 1/4 in. (690 mm) in width and 6 in. (150 mm) in thickness.
- The guardrail provided must be used to avoid the formation of a gap between the mattress and the bed that could cause an entrapment.
- Do not place bed near windows where cords from blinds or drapes may strangle a child.
- Do not place items with a string, cord, or ribbon around a child's neck, such as hood strings or pacifier cords.
- Do not suspend strings over a toddler bed for any reason or attach strings to toys.
- The minimum age of the intended user shall not be less than 15 months and the maximum weight shall not be greater than 50 lbs. (22.7 kg).



CARE AND MAINTENANCE

Our beautiful crafted children's furniture is the result of four generations of craftsmanship and tradition. Each piece is created with as much attention and devotion as it was in our first workshop at our family home in 1919. The following care and maintenance recommendations will help to protect your Pali furniture investment:

- Sharp clothing articles like belt buckles and zippers will damage your furniture if they rub against it. Be particularly careful when you are close to the crib or dresser to avoid damaging your furniture.
- Avoid placing furniture directly under windows, in direct sunlight or in a damp area.
- Position your furniture away from heating or air conditioning vents.
- Use either a humidifier or de-humidifier as needed to keep the air in the room from becoming too dry or too damp.
- Dust your furniture frequently using a soft cloth to keep the build up of dirt to a minimum and help prevent scratches and ground-in grime.
- Only polish your furniture every 4-6 months and be sure to use polish that does not include silicone or wax that can damage the furniture finish.
- Do not place hot or extremely cold items directly onto the furniture surface as this can discolor the finish.
- Take care to lift your furniture when moving in order to prevent damage to the legs caused by pushing or dragging.
- When cleaning your crib, please use a non-toxic, non-abrasive cleaner. Mix a solution of water with a small amount of mild dishwashing liquid. Apply to crib surface with a soft, damp cloth lightly dampened in solution. After cleaning, dry completely with a soft, dry cloth.
- When storing crib use caution as extreme changes in temperature or humidity can compromise the crib making it extremely dangerous to your child.

Assembling Crib

- This crib has three mattress support positions for use in your baby's first months.
- As soon as baby starts to sit up you must use the lowest mattress support position.
- To assemble the crib with the high mattress support position see Step 1.
- When using the crib as a toddler bed, remove the Footboard and the lower mattress support position must be used.

Hi Mid Lo

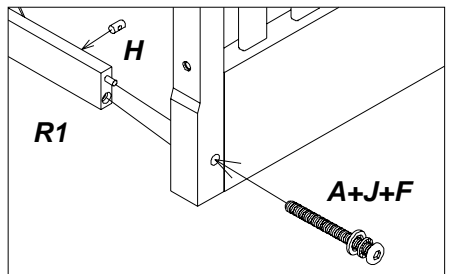
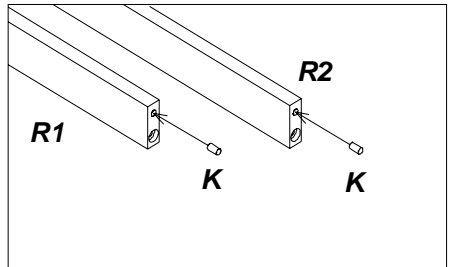
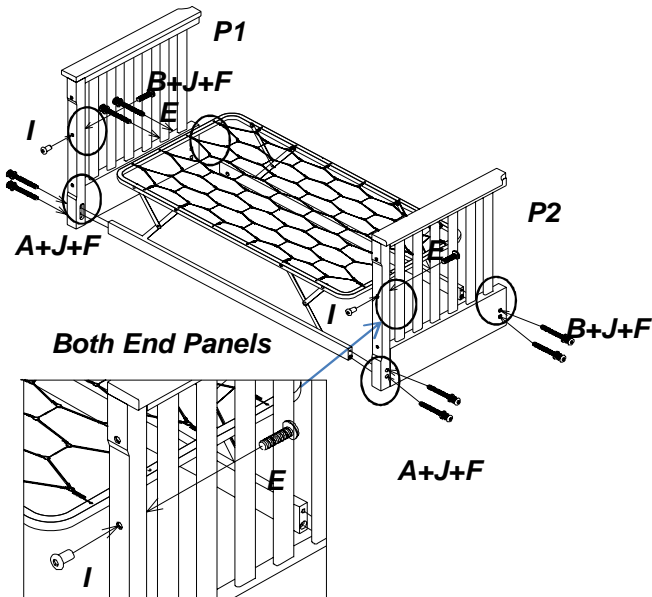
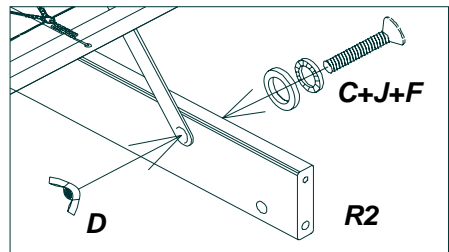
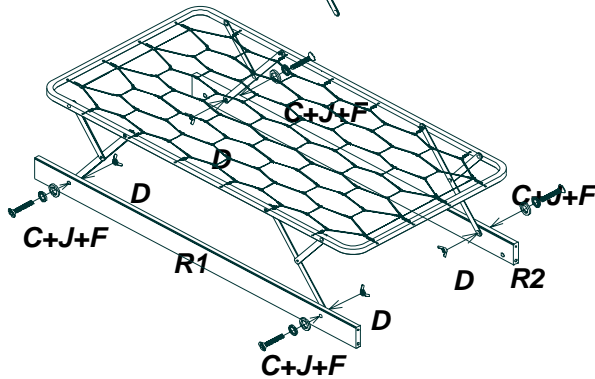
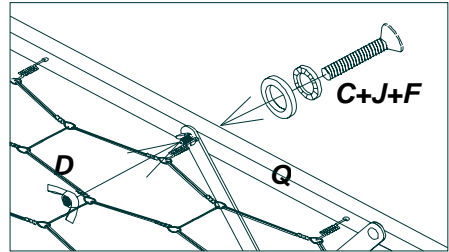
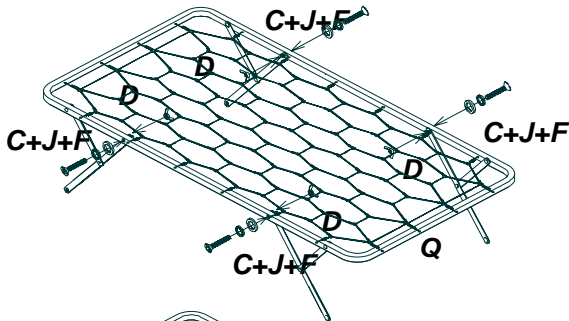
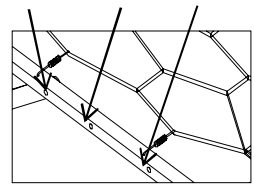

Cover Holes

CRIB Step 2 **Attaching the Sides (End Panels)**

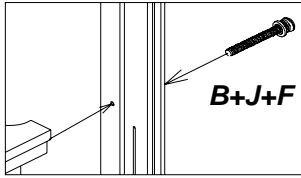

Left

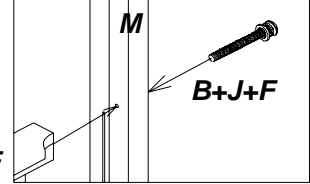
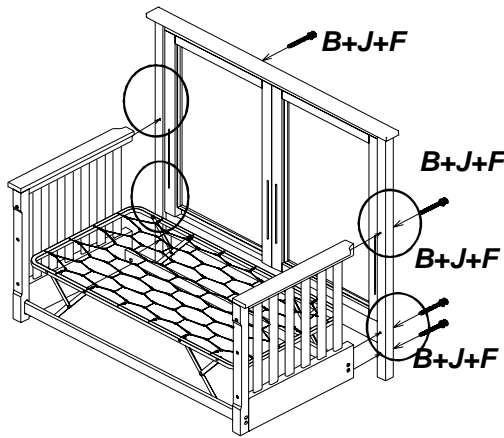
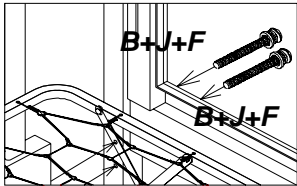

Right

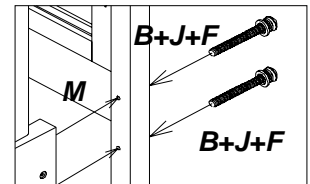

CRIB Step 3 **Attaching the Footboard**

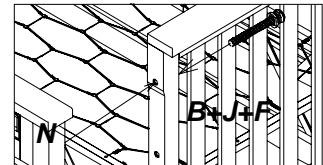
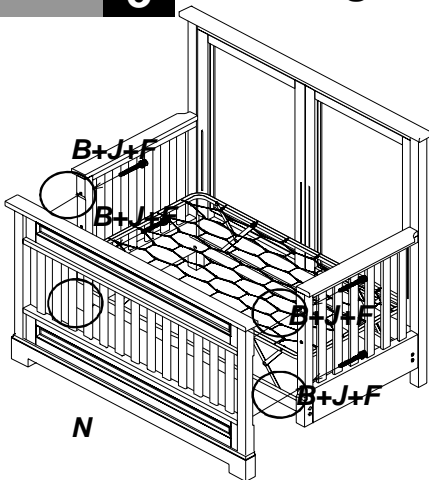

Both End Panels

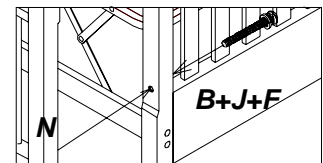

Crib

**Toddler Bed +
Child's Day
Bed**

**Step
1**

Transforming Crib into Toddler Bed or Child's Day Bed

(3515 Toddler Rail Kit sold separately)

•Additional hardware pictured are provided in the Toddler Rail hardware pack

•When using the crib as a toddler bed, remove the Footboard and lower the mattress to the lowest position.

•Keep all bolts and cap nuts to cover holes in child's day bed conversion.

Uncover Holes

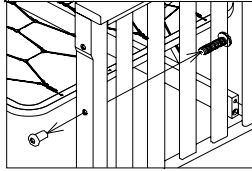

Both End Panels

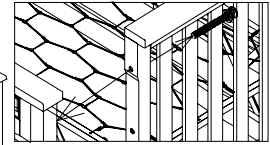
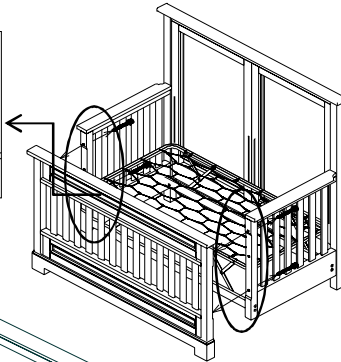

Both End Panels

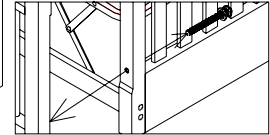

**Toddler
Bed**

**Step
2**

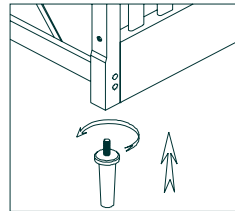
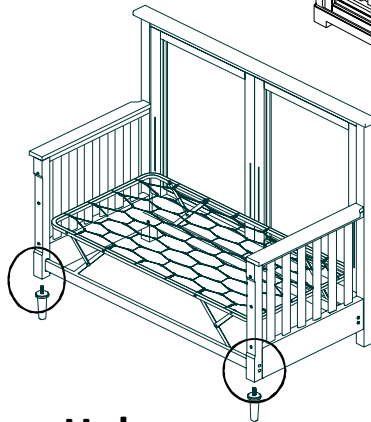

**Both
End
Panels**

**Toddler
Bed**

**Step
3**

Cover Holes

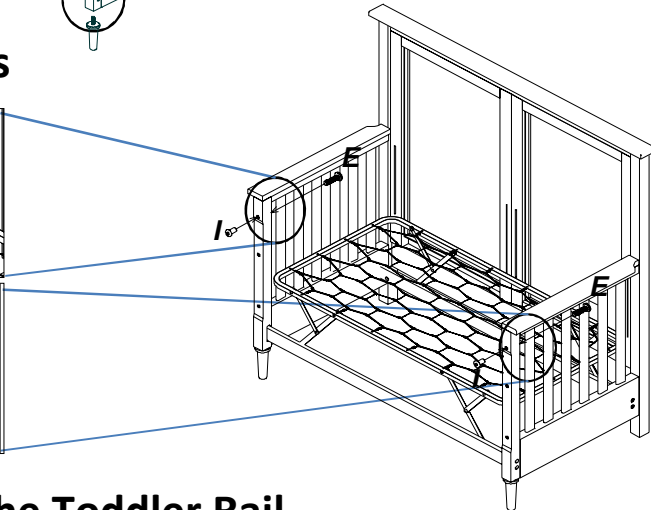
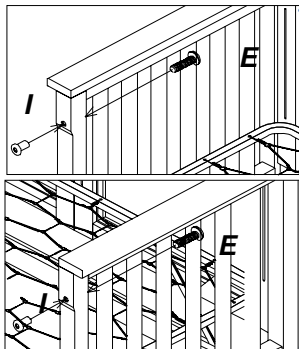

**Toddler
Bed**

**Step
4**

Attaching the Toddler Rail

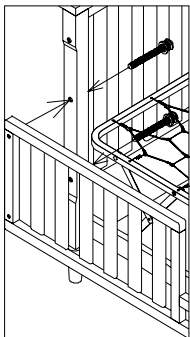

Left

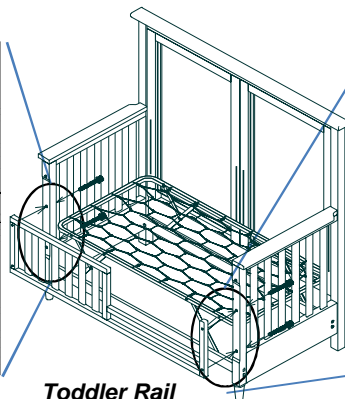

Toddler Rail

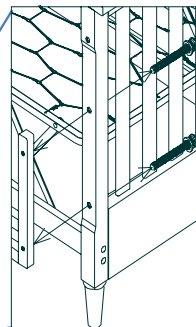

Right

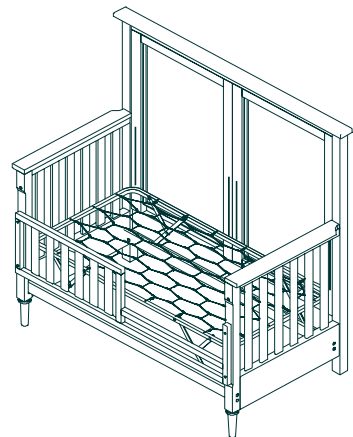

Toddler Bed

Remove the Toddler Rail

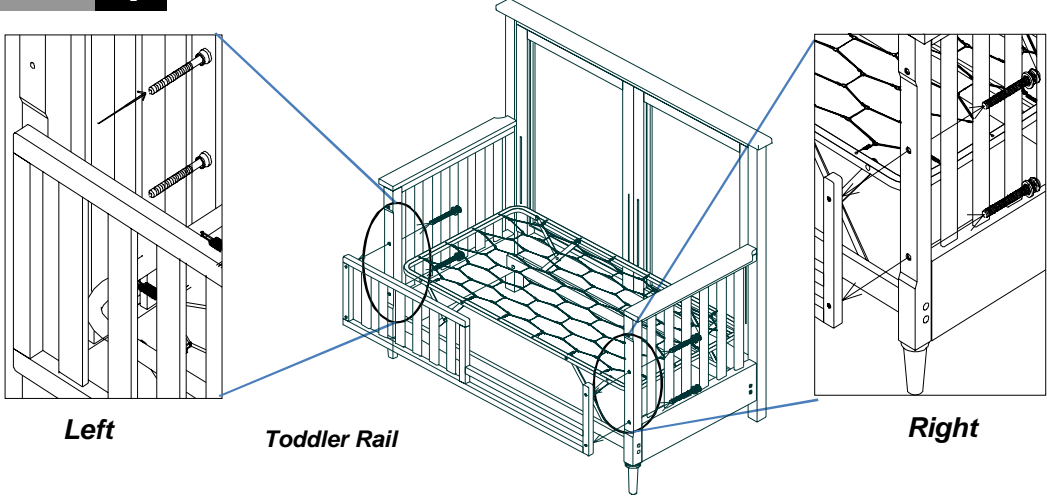

Cover Holes

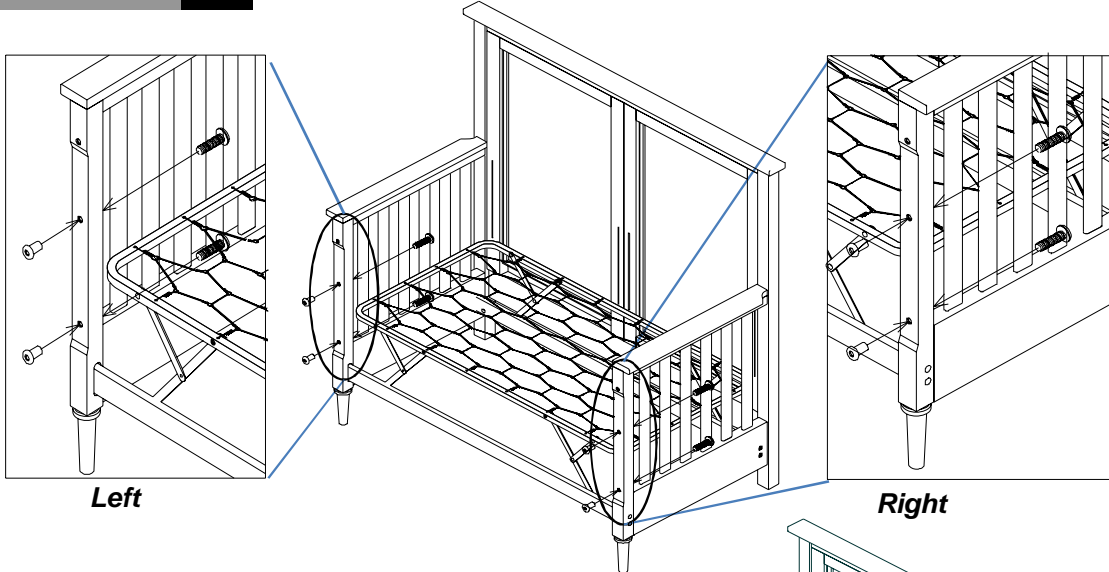

Child's Day Bed

